

LITE LEVEL



INDEX

1. Code registry
2. Description
3. Single elements
4. Technical specification

1. CODE REGISTRY

Code	Description	Colour	Dim. (mm)	Weight	Bag / Pallet
TER04-4450DK	Spin Leveling cylinder for Lite Level System	Blue	-	0,008 kg/pz.	50 pz. / 180 bags

MATERIAL Made of recycled plastic material

2. DESCRIPTION

The cylinder is made of recycled plastic material and available delivered in bags of 50 pieces.

The New Cylinder works with all the range of actual screw spacers:





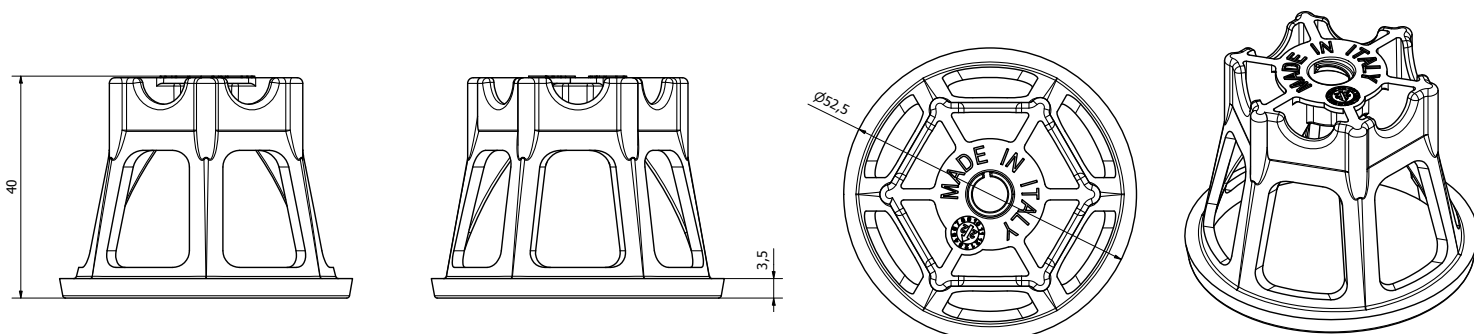



- **Linear** spacer Screw for 1, 1.5, 2, 2.5, 3, 4 mm grout joints.
- **Cross** spacer Screw for 1, 2, 3 mm grout joints.
- **T** spacer Screw for 1, 2, 3 mm grout joints.

The use of the cylinder with the spacer screws allow to remove any difference between tile and tile during the laying, obtaining a coplanar and equidistant result without any lippage.



LITE LEVEL

3. SINGLE ELEMENTS

Code	Description	Photo	Misure (mm)	Bag	Box	Pallet	UM
TER04-4401DK	Linear spacer screw 1 mm		1	100 pcs.	25 bags	375 bags	bag
TER04-44015DK	Linear spacer screw 1,5 mm		1,5	100 pcs.	25 bags	375 bags	bag
TER04-4402DK	Linear spacer screw 2 mm		2	100 pcs.	25 bags	375 bags	bag
TER04-44025DK	Linear spacer screw 2,5 mm		2,5	100 pcs.	25 bags	375 bags	bag
TER04-4403DK	Linear spacer screw 3 mm		3	100 pcs.	25 bags	375 bags	bag
TER04-4404DK	Linear spacer screw 4 mm		4	100 pcs.	25 bags	375 bags	bag
TER04-4421DK	Cross spacer screw 1 mm		1	100 pcs.	25 bags	375 bags	bag
TER04-4422DK	Cross spacer screw 2 mm		2	100 pcs.	25 bags	375 bags	bag
TER04-4423DK	Cross spacer screw 3 mm		3	100 pcs.	25 bags	375 bags	bag
TER04-4431DK	"T" shape spacer screw 1 mm		1	100 pcs.	25 bags	375 bags	bag
TER04-4432DK	"T" shape spacer screw 2 mm		2	100 pcs.	25 bags	375 bags	bag
TER04-4433DK	"T" shape spacer screw 3 mm		3	100 pcs.	25 bags	375 bags	bag
TER04-4410DD	Cross anti-scratch pad		-	50 pcs.	10 bags	300 bags	bag

4. TECHNICAL SPECIFICATION

Specification	Description	Unity	Price
Dak.I.TER04.4450DK	Supply and installation of leveling system and spacer for floor and wall tiles of various sizes and thicknesses, in single bag composed of 50 cylinders. A system composed of 2 elements (cylinder with optional cross scratch proof disc and spacer screw) that assembled and adjusted, allows, to remove any difference between tile and tile during the laying, obtaining a coplanar and equidistant result without any lippage. Linear spacer Screw are available for 1, 1.5, 2, 2.5, 3, 4 mm grout joints. Use as a levelling tool for tiles of various dimensions and sizes.	bag	-