

HERCULES SELF-LEVELING HEAD - PAVING

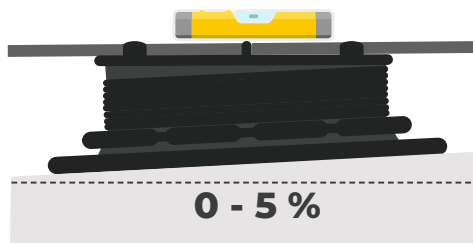

INDEX

1. Code registry
2. Description
3. Use
4. Carrying capacity
5. Fields of use
6. Technical specification

1. CODE REGISTRY

Code	Description	Measure (mm)	Weight (kg)	Pkg / Pallet
TER09-1183/4L25	Hercules Paving - Self-Leveling Head 4 mm joint	from 25 to 37	0,223	30 pcs. / 720 pcs.
TER09-1183/4L37	Hercules Paving - Self-Leveling Head 4 mm joint	from 37 to 60	0,284	30 pcs. / 480 pcs.
TER09-1183/4L60	Hercules Paving - Self-Leveling Head 4 mm joint	from 60 to 94	0,408	25 pcs. / 300 pcs.
TER09-1183/4L94	Hercules Paving - Self-Leveling Head 4 mm joint	from 94 to 150	0,543	20 pcs. / 160 pcs.
TER09-1183/4L150	Hercules Paving - Self-Leveling Head 4 mm joint	from 150 to 270	0,736	15 pcs. / 120 pz.
TER09-1183/P120	Extension for Hercules 150 - 270	h. 120	0,186	1.200 pcs.
TER09-1183/CHI	Adjustment key for Hercules	-	0,200	12 pcs. / -

MATERIAL Made of PP (polypropylene).

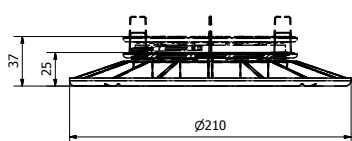

TER09-1183/4L25

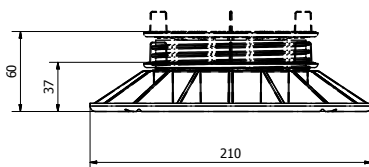

TER09-1183/4L37

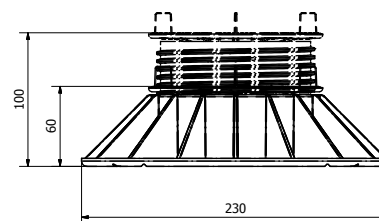

TER09-1183/4L60

HERCULES SELF-LEVELING HEAD - PAVING

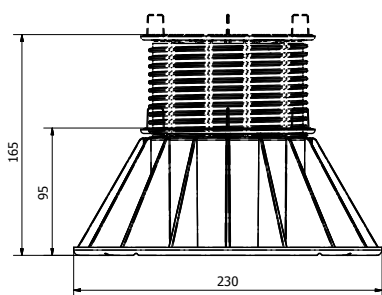

TER09-1183/4L94

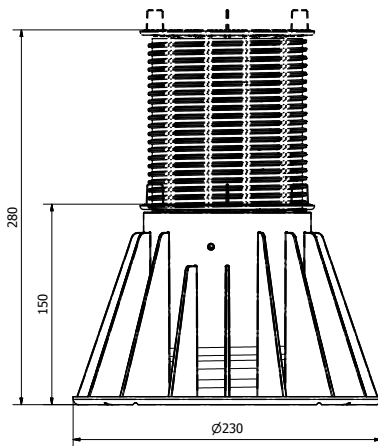

TER09-1183/4L150

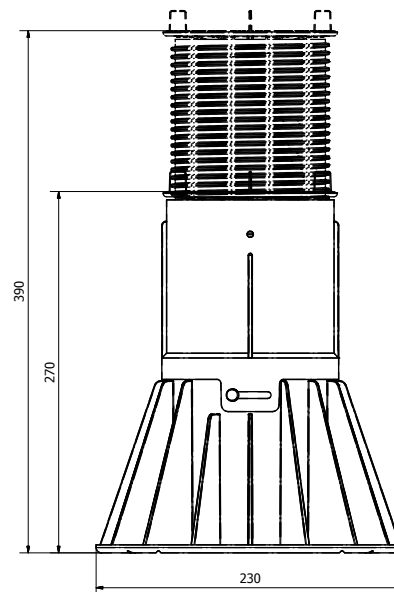

TER09-1183/4L150 + TER09-1183/P120

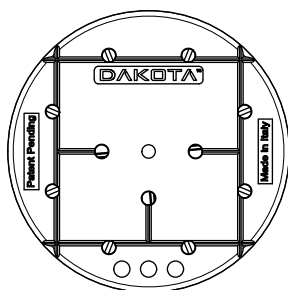
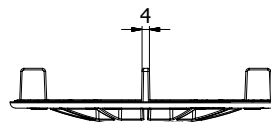

RETRO BASE

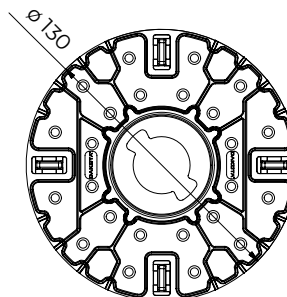

SELF-LEVELING HEAD

2. DESCRIPTION

Hercules adjustable support for outdoor flooring, with adjustable height from min. 25 to max. 390 mm (depending on the model used).

Each pack contains the complete disassembled support with base, screw and self-levelling head (till 5%) for paving with 4 removable wings for 4 mm joints.

The head is equipped with integrated anti-noise rubber. Only the model from h. 150 to 270 mm can be extended by applying the specific extension h. 120 mm (TER09-1183 / P120). The finalization of the adjustment of the support takes place with the floor installed using the appropriate key.

3. USE

Used in external areas, terraces, pavements.

4. CARRYING CAPACITY

- Minimum load capacity = 15 kN (totally extended)
- Maximum load capacity = 30 kN (completely not extended)

HERCULES SELF-LEVELING HEAD - PAVING

5. FIELDS OF USE

Waterproof membrane, hard insulating panels, squids and solid and compact pose plans



6. TECHNICAL SPECIFICATION

Code	Description	Unit	Price
Dak.D.TER09.1183/4Lxxx	Hercules adjustable support for outdoor flooring Dimensions, with height from min. 25 to max. 390 mm (depending on the model used). Available in black color Made of polypropylene Used in external areas, terraces, pavements.	pc.	-
Dak.D.TER09.1183/4L25	Hercules Paving - Self-Leveling Head 4 mm joint from 25 to 37 mm, base diameter 210 mm.....	pc.	-
Dak.D.TER09.1183/4L37	Hercules Paving - Self-Leveling Head 4 mm joint from 37 a 60 mm, base diameter 210 mm.....	pc.	-
Dak.D.TER09.1183/4L60	Hercules Paving - Self-Leveling Head 4 mm joint from 60 a 94 mm, base diameter 230 mm.....	pc.	-
Dak.D.TER09.1183/4L94	Hercules Paving - Self-Leveling Head 4 mm joint from 94 a 150 mm, base diameter 230 mm.....	pc.	-
Dak.D.TER09.1183/4L150	Hercules Paving - Self-Leveling Head 4 mm joint from 150 a 270, base diameter 230mm.....	pc.	-
Dak.D.TER09.1183/P120	Extension h.120mm in polypropylene compatible with Hercules support 150, TER09-1183/1F150	pc.	-